

Article number: 20171B202BL

Description: E+G

Corner base clamps GN167-B20-2-BL

Measures

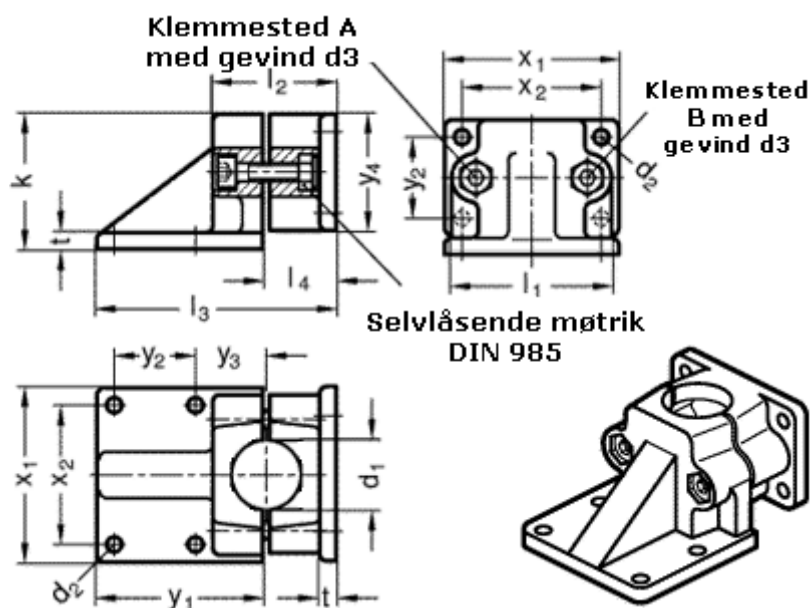

d1 = B20	t = 7
d2 = 7	x1 = 75
d3 = M 8	x2 = 60
k = 58	y1 = 72
l1 = 69	y2 = 35
l2 = 53	y3 = 30
l3 = 103	y4 = 50
l4 = 30	